

RE-INVENTED RECLINER™ COLLECTION

CALLUM



**AMERICAN
LEATHER®**

Standard Features:

- Advanced unidirectional suspension system
- Premium high-density, high-resiliency foam seat
- Tight back and seat cushion
- Double-needle quilting combined with single-needle top-stitch with thick thread
- Limited lifetime warranty on frame and suspension
- Three-year warranty on mechanism
- Quick-ship delivery

Options:

- Wood arms in Dark Brown Ash or Natural Walnut

Additional Power Options:

- Motorized recliner with an on-seat control panel that is easy to use and includes a USB charging port
- Motor has a limited three-year warranty
- Lithium-ion battery pack available
- Battery pack has a one-year warranty

Please use actual leather, fabric, Crypton®, Sunbrella® and Ultrasuede® swatches when specifying furniture as the colors shown may vary due to the printing process.

Wall Clearance is 16"

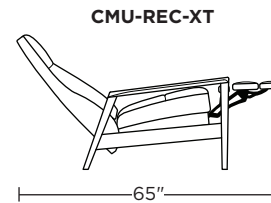
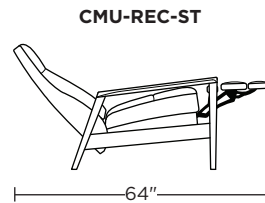
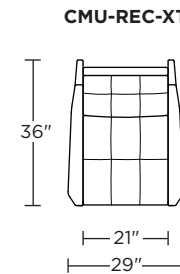
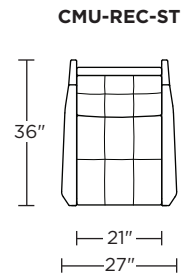
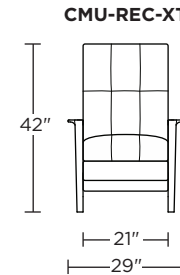
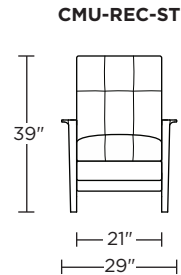
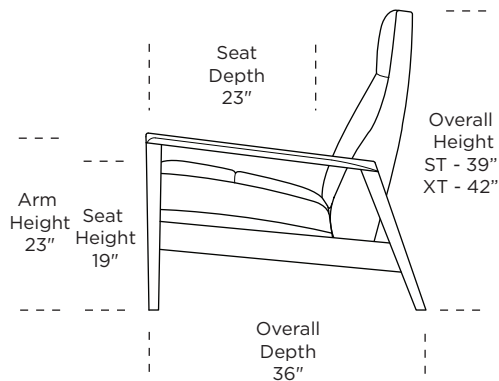

Scale: 1/4 inch = 1 foot
All dimensions are approximate and subject to change.
Specify components from the sitting position.